

# SUNUP



User Manual



## Portable Dental X-ray System

**MODEL : MX-PLUS**

# SUNUP

Taizhou Zhonglian medical technology Co.,Ltd

Adress: #168 west Phoenix road Taizhou China

Sales call: 0086-523-89993222

Service: 008613357797788

E-mail:sunup@cn-sunup.cn

Http://www.cn-sunup.cn

The graphic images in this manual can be different form the one in the actual product.  
Thank you for purchasing PLUS. Please read this manual carefully before using PLUS.  
The quality of this product guarantee is contained in this manual.

## Super Small ! Super Light !

- ☞ Convenience of cordless
  - Use the charging battery-pack take-off type
- ☞ Adopting high-frequency circuit of inverter type
- ☞ The most suitable to diverse digital sensors.
  - Simultaneous using of digital sensor and film
- ☞ Auto set Timer
  - Automatic exposure time set up by adult, child, and location of teeth
- ☞ More than 300 radiography is possible with one time charging of battery
- ☞ More compact/weight than existing portable dental X-ray (1.8Kg)

**User Manual**

# Contents

## User Manual

1. Contents .....	4
2. Preface .....	6
3. Safety Marks .....	7
3.1 Warning .....	8
3.2 Caution .....	10
3.3 Checking for Confirmation .....	10
4. Features of product .....	11
5. Specifications .....	12
6. Product consist .....	15
7. Product Description	
7.1 Features .....	16
7.2 LCD Window and functions .....	18
7.3 Each part of the button and functions .....	19
7.4 X-ray Exposure using Remote control .....	20
7.5 Replacement and charge of the battery-pack .....	21
7.6 Battery-pack charge .....	22
8. Operation	
8.1 Starting and ending of system .....	24
8.2 X-ray generating time control .....	24
8.3 Relation between X-ray generating time and part of teeth (table) .....	24
8.4 X-ray EXPOSURE .....	26
8.5 User Set Up Mode .....	27
8.6 Replacing and charging of battery-pack .....	30

9. Maintenance and Keeping .....	31
10. Instruction and Troubleshooting guidelines .....	34
11. Quality Guaranteed .....	35
12. Warranty .....	36
13. Instruction for Quick Start .....	37
Service Manual	
Specifications .....	40
High Voltage Tank .....	42
Electro-Magnetic Compatibility .....	49
Radiation Safety .....	50

## 2. Preface

Thank you for purchasing the portable X-ray system of Resun Co., Ltd. This product has been so developed as to not only take radiographs in analog way using conventional film, but also be used in Dental Digital Radiograph, DDR using digital sensor as well. Please use following requirement for application.

Indications For Use... The Mx-Plus is a portable x-ray system indicated for taking diagnostic dental x-rays for both pediatric and adult patients using intraoral film or digital sensors  
 Prescription-Use Statement... This device can only be sold on or by the order of a physician or other properly licensed health care professional.



### WARNING

This X-ray unit may be dangerous to patient and operator unless safe exposure factors and operating instructions are observed.



### TYPE B Applied Part

Type B Applied Part provide the lowest degree of patient protection of all the types of applied part and are not suitable for direct cardiac application.



For proper and safe use of this product, this device has to be used only authorized and qualified personal as doctors and diagnosis and treatment X-ray engineers, and has to be used after fully familiarized with user manual.

## 3. Safety Marks

Warning, caution, and acknowledgement indication in this manual are provided for assuring of proper use of the product to protect the user's safety and to prevent the loss of the property. Therefore the users have to observe these safety requirements.



Consult accompanying documents.

This symbol advises the reader to consult the accompanying documents.



Warning

Warning marks indicate and explain for the cases which might be harm to the user, cause death or property damage.



Caution

Caution marks indicate and explain for the cases which might cause harm to the body due to improper use of the product.



Check

The check marks indicate and explain for The cases which the user must follow in installation, operation and maintenance/repair of this product.



Radiation Warning

“Radiation Warning” sign explains details of possible user radiation hazard.



## 3.1 Warning

### 1. In use

- Not to exceed the dose of X-ray that is necessary for image diagnosis.
- Be handled or operated only by qualified personnel.
- Something wrong with the patient during using of the product.
- Proper actions have to be taken such as stop the using product.
- Stop operating the unit, when there is problem with the unit. Please, contact the authorized A/S center.
- Use the product avoiding the follow places.
  - Where there is chemical material or explosive gas.
  - Where it is damp.
  - Where there is direct ray of light
  - Where ventilation is poor
  - Dusty place
  - Humid place
  - Salty place

- Product transportation, storage conditions and conditions of use ;

#### 1. Transportation and storage conditions

- Temperature: 0 ~ 40 °C
- Humidity: 30 ~ 75 %
- Atmosphere pressure: 700 ~ 1060Hpa

#### 2. Optimal conditions of use

- Temperature condition of use: 10 ~ 30 °C
- Humidity condition of use: 30 ~ 60 %
- Atmosphere pressure condition of use: 900 ~ 1060Hpa

### 2. Safekeeping not in use

- Do not keep the unit where it is damp, salty, and dusty, which might cause the bad effects for operating of the unit.
- Do not place the unit long at the place where the temperature changes steeply or in the direct ray of light.
- Do not keep the unit where there is explosive gas or chemical materials.
- Do not keep the battery-pack long in the charger while connecting with the electricity.
- Keep the charged battery-pack in the separate keeping case.

### 3. Other

- Contact the authorized A/S center in case of the unit is out of order.

## Discard



in the EU this Symbol indicates waste of electrical and electronic equipment must not be disposed as unsorted municipal waste and must be collected separately. To minimize the risks involved in disposing of these waste products, please contact an authorized representative of the manufacturer or an authorized waste management company for information concerning the decommissioning of your equipment.



### 3.2 Caution

- Do not expose the unit to the extreme shock or vibration Do not use the unit, placing it at dusty, dirty, and inclined place.
- Do not jerk the connection cable between the charging desk device and the charger
- Do not allow the patient touch the unit and do not leave the unit within the reach of the patient



### 3.3 Confirmation check

- Check the condition of the battery-pack and the unit before using, make sure the proper peration state of the unit
- Check again the parts of the unit that is touching directly the patient.
- Use the unit according to the procedure for operation
- Use the unit in the comfortable place where ventilation is good
- After using of the unit, check indicating lamp for remaining battery without fail and charge the battery if the remaining of the battery is not sufficient.
- For charging of battery-pack, use only the exclusive charger without exception.
- Keep the unit clean by using the clean dry piece of cloth to prevent the terminal of battery-pack from touch of metal and other different materials.
- The unit and parts should have the regular check without fail.

## 4. Features of product

- Name of product : Portable X-ray System
- Model : MX-Plus
- MX-Plus is a portable x-ray system indicated for taking diagnostic dental x-rays for both pediatric and adult patients using intraoral film or digital sensors
- Real meaning portable system by using replaceable battery-pack
- Graphic LCD window and user-friendly interface by simple button-touch Life time is 8 years
- LCD window indicates;
  - Exposure time setup by adult and child
  - Film and digital mode
  - Operation status of the unit
  - Remaining of battery
  - Exposure time setup by part of the teeth
- Function for user
  - Simultaneous use of digital and film
  - Automatic power disconnecting time setup
  - Continuation of back light time setup
  - Remaining voltage of battery indication
- 3-steps time increase level by part of teeth

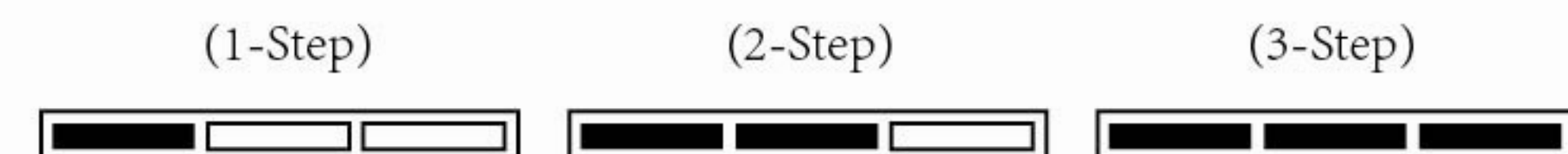

## 5. Specifications

- Name : Mobile X-ray System
- Item Classification : 2, Code: A11080.02
- Grade : Class II b (MDD 93/42/EEC as amended by 2007/47/EC)
- Classification : B Type applied part
- Tube Voltage : 60kV (fixed)
- Tube Current : 2mA (fixed)
- X-Ray Tube Focal Size : 0.7mm
- Cooling system : Oil cooling
- Total filtration : 1.5 mm Al  
(Inherent filtration : 0.8mm Aluminum)
- Target angle : 16°
- Time Set-up function : 0.05 ~ 1.35 sec (Film/Digital included)
- Source to image receptor distance : >10cm (fixed by cone)
- X-ray field : 50mm(round-style)
- Size of main body : 139(W) x 168.5(H) x 66.5mm(D)
- Weight of body : About 1.8 kg (except the battery pack)

## Specifications

- Battery-pack
  - Material : Lithium-Polymer
  - Charge Condition
    - Current : 1.0 A
    - Voltage : 16.8 VDC
    - Temperature : 0 ° C ~ 40 ° C
  - Use condition
    - Max. current : 20A
    - Voltage range : 12(min) ~ 16.8(MAX) V
    - Temperature : -20 ° C ~ 60 ° C
- Charger
  - Input Voltage : 100 ~ 240 VAC
  - Output Voltage : 16.8 VDC
  - Current : 1.0A

## Specifications

- Distance from X-ray focal source to X-ray field and angle

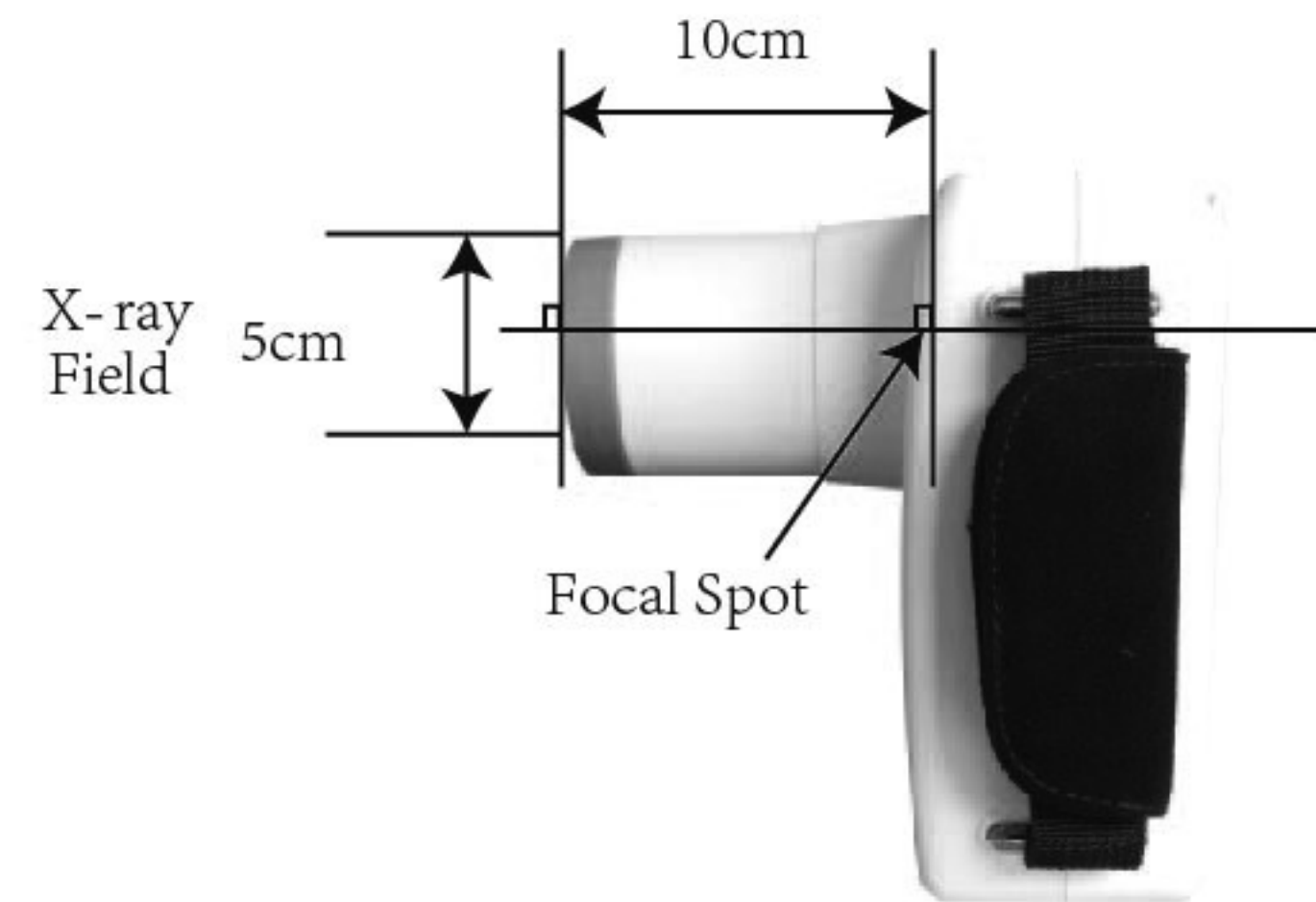

- Please use this product by Hand-Held like below picture.



Don't put any material that can attenuate intensity of X-ray between X-ray field and subject at X-ray exposure.

## 6. Product consist

- Portable X-ray System : M
- Components
  - Battery-pack 2EA
  - Battery charging adapter 1EA
  - Battery charging cradle 1EA
  - Power cord 1EA
- Accompanying document
  - User Manual CD
  - Quality Assurance
- Keeping case



## 7. Product description

### 7.1 Features

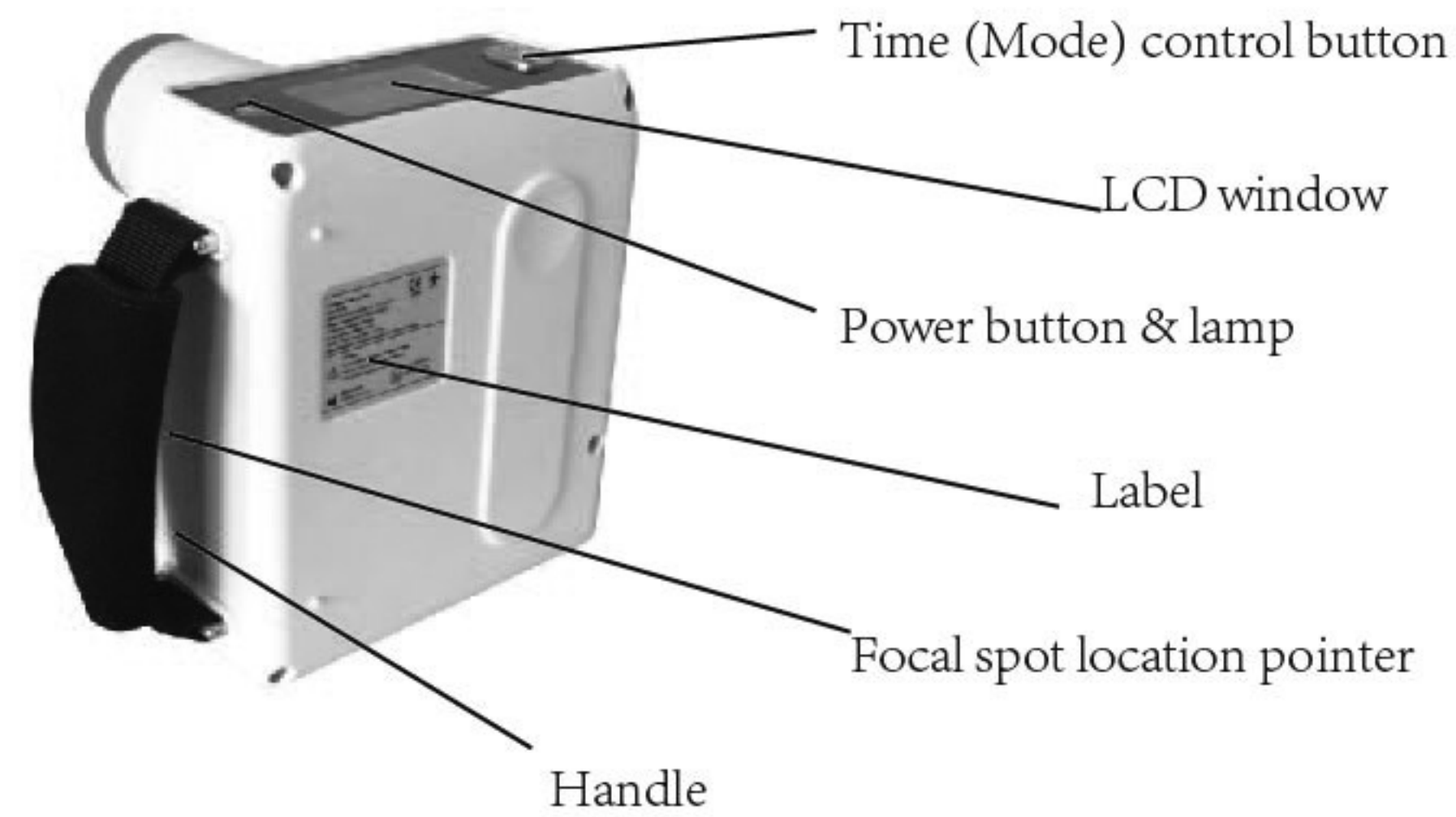
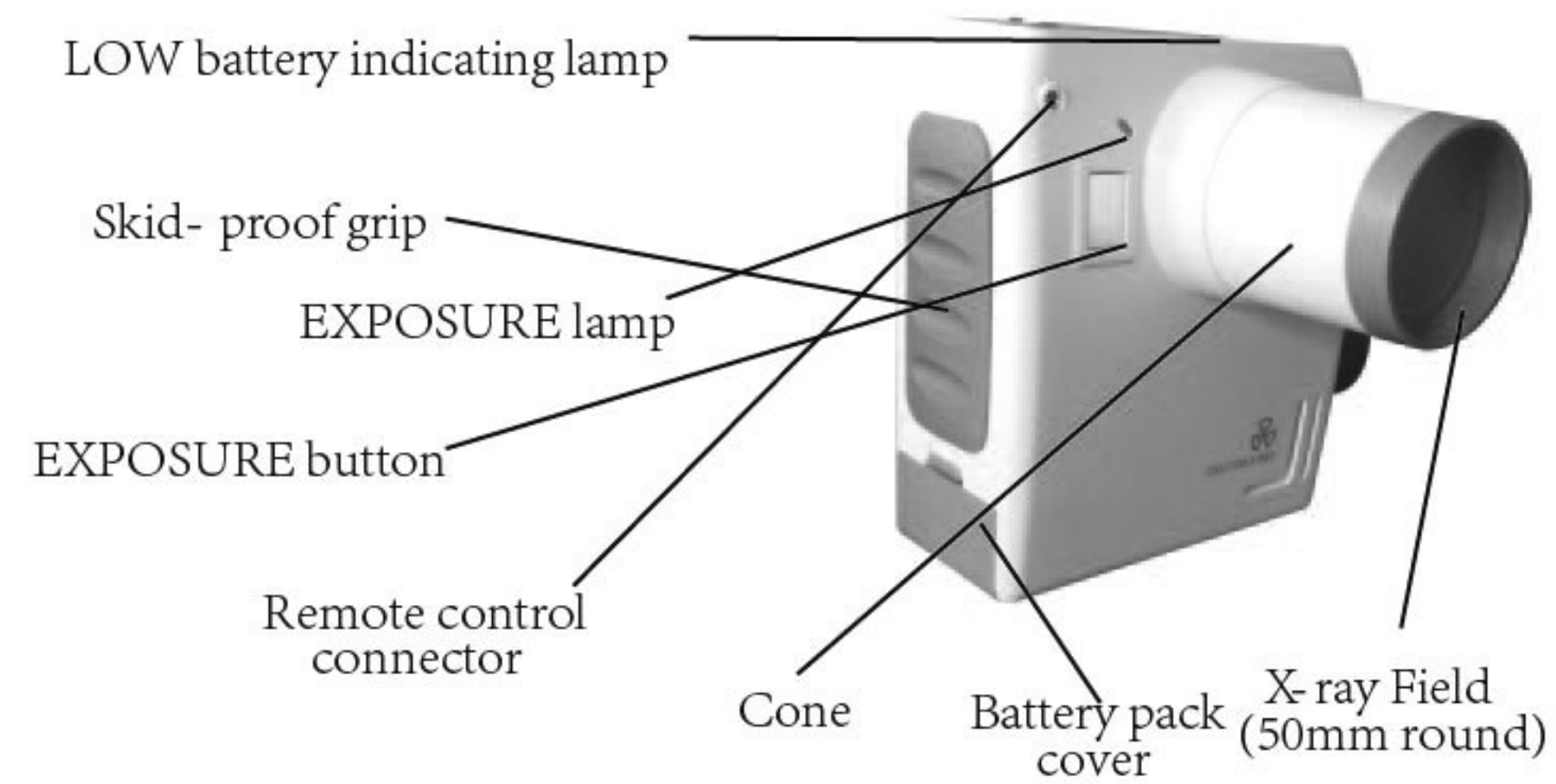

The design of the product is subject to change without notice to enhance the performance.

## 7. Product description

### 7.1 Features

CAUTION, CONSULT ACCOMPANYING DOCUMENTS

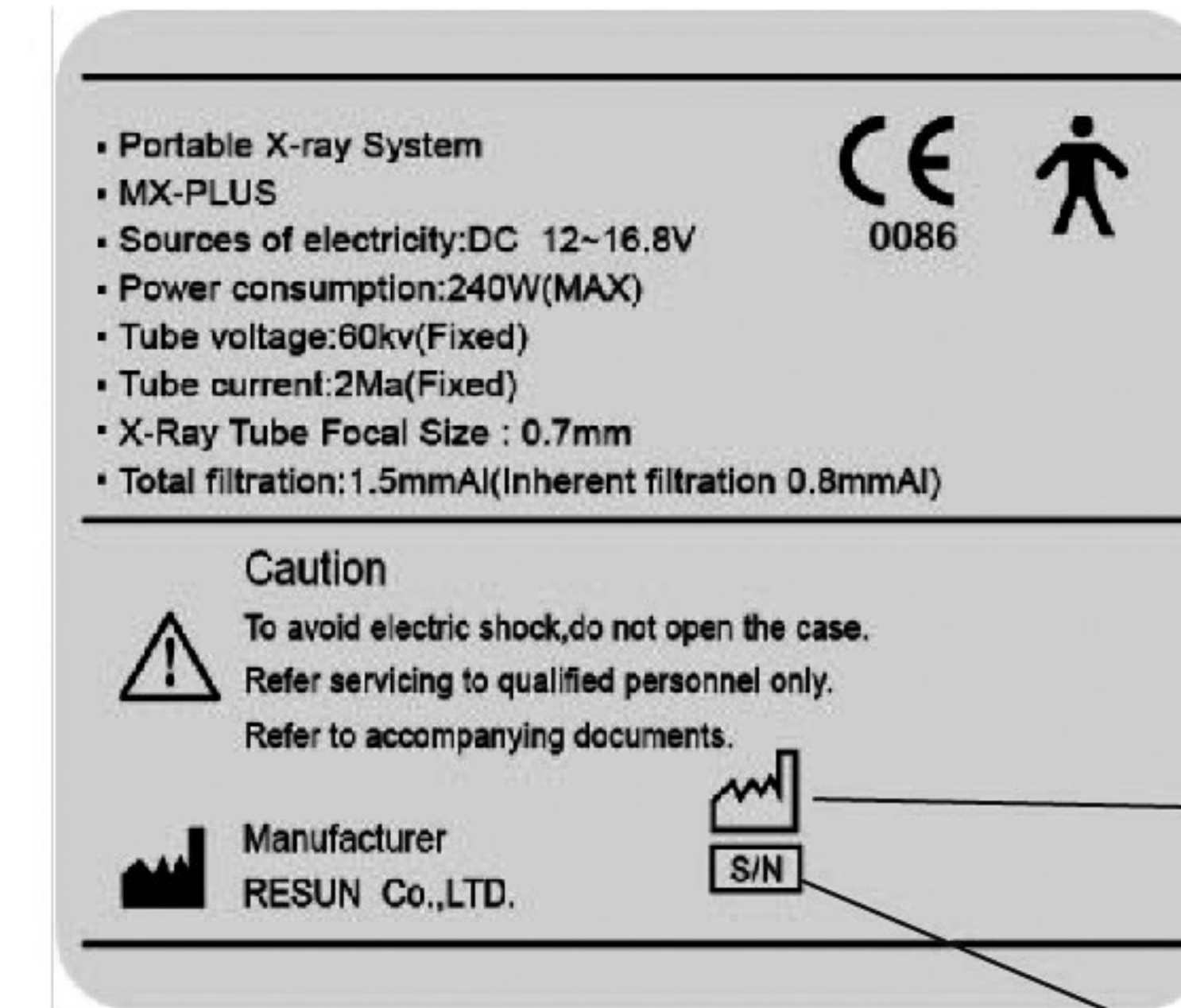

DATE OF MANUFACTURE

SERIAL NUMBER

PRODUCT LABEL STICKER

AUTHORISED REPRESENTATIVE IN THE EUROPEAN COMMUNITY



The design of the product is subject to change without notice to enhance the performance.

## Product Description

### 7.2 LCD Window and functions

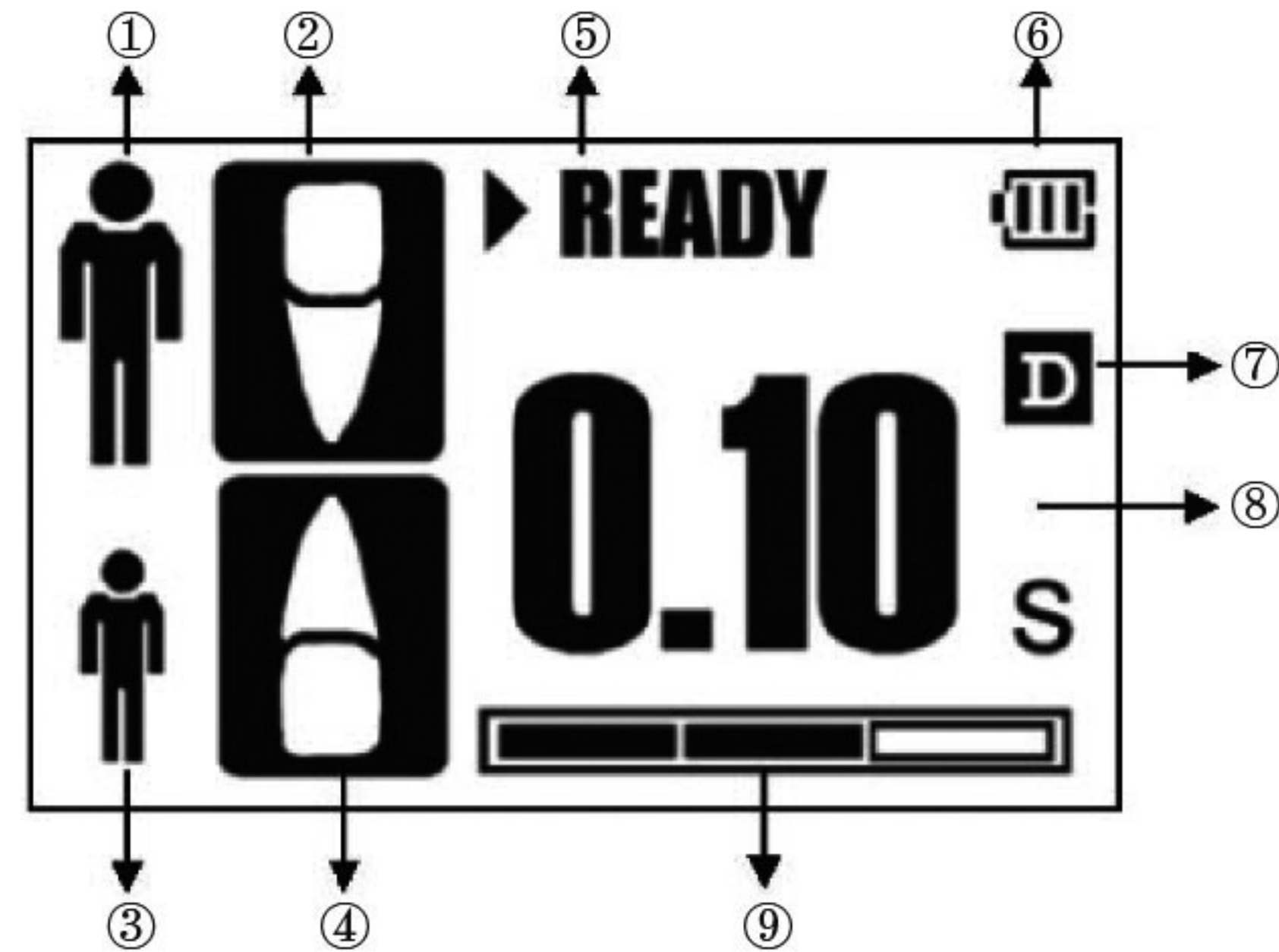

- ① Adult mode : Adult mode indicates
- ② Teeth part of adult : Adult teeth part indicates
- ③ Child mode : Child mode indicates
- ④ Teeth part of child : Child teeth part indicates
- ⑤ Indication of status : Indication of the present operation of the unit
- ⑥ Status of battery : Indicate the remaining of battery by 3-steps
- ⑦ Digital mode icon : Indicates digital sensor is setup and disappears when film mode is setup. (default is film mode)
- ⑧ Exposure time display : Indicates irradiation time at each part of teeth mode
- ⑨ 3-step time increase level by part of teeth





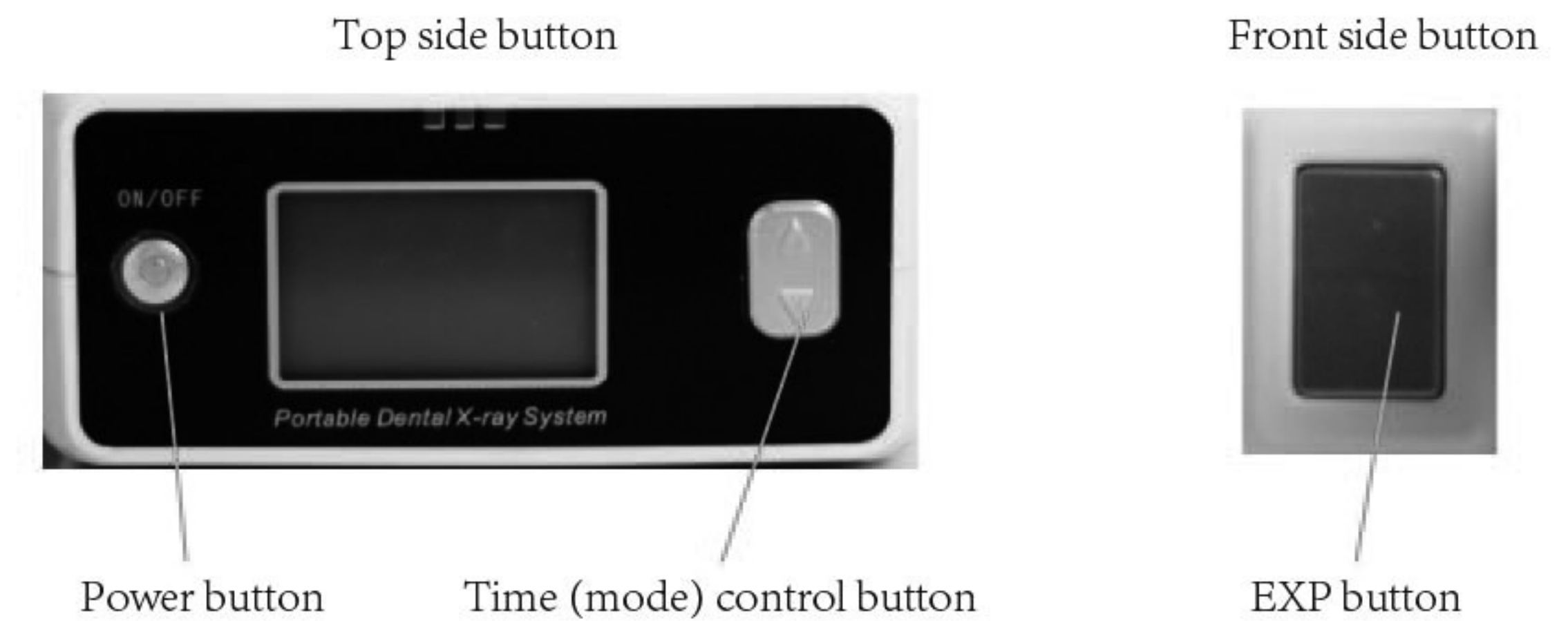

The specifications and functions in this manual are subject to change without notice to enhance the performance.

## Product description

### 7.3. Each part of the buttons and functions



-  button : Turn on/off the unit
-  button : Time increase
-  button : Time decrease
-  button: Exposing of X-ray with buzzer sound only while the button is being pressed and irradiation will stop when button is released.  
(DMS method-Dead Man Switch)

## Descriptions

### 7.4 X-ray Exposure using Remote control



Allows user to operate X-ray by way of approved remote control.



- Use only approved Remote Control.
- Approved remote control is not included with the X-ray, but can be purchased as an option from distributors.

## Product description

### 7.5 Replacement and charge of the battery-pack



[LCD Screen when low battery]

- The battery pack replacement
  - If LOW battery direction ramp is blinking or LOW battery sign appears on battery pack residual quantity expression. (🔋)
  - Turn off the power when the LOW battery sign appears. Please open the battery pack cover and change with extra battery pack.
  - Fixing lever down and then pull the cover forward for opening the battery pack cover.
  - Put homologizing correctly guide line of the pack top portion and battery pack insertion slot of device.
  - Please close cover after making sure whether battery pack came into end certainly.



Please change battery pack when LOW battery sign of LCD screen blinking for expend the length of using battery pack.



When change battery pack, please take care not to drop battery pack.

## Product description

### 7.6 Battery-pack charge

- Please power plug of AC code to concert after connect device for charger and charger.



- Please thread battery pack when battery pack is inserted to battery pack holder to direction that is correct on slot of device for charger.

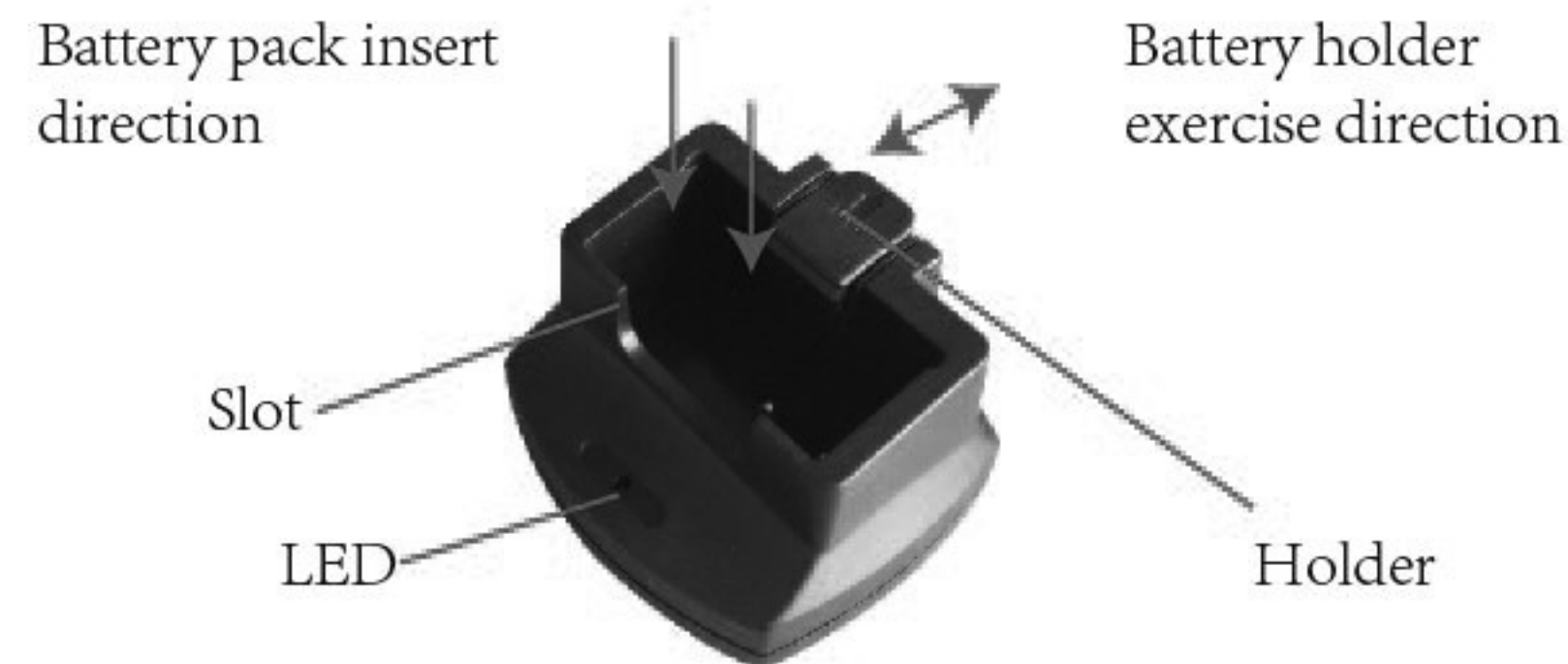

- If the charge is completed, charge lamp changes from red color to green.
- When segregate battery pack in device for charger after charge is completed, please pull backward and segregate battery pack holder.



Keep the battery pack separately or unplugged after charge lamp changes green or not in use.

## Product description



Please keep the following rules whenever charging the battery pack.

Use only appointed charger and battery pack.

Keep apart the battery pack in the special storage case after charging completed.

Avoid the recharge for charge completed pack.

Take care not to contact the metal goods of coin, key, clip etc. on the battery terminal plate.



Battery pack is consumer goods

Duration of battery-pack is shorted slowly than first purchase. Please buy new battery pack if duration decreases by half than when use first. Purchase inquires in the A/S center.

Exhaust of battery pack

Used battery pack should not throw away in trash but please put that in the recycling box or exclusive case.

## 8. Operation

### 8.1 Starting and ending of the system

Press the power button during “1 second” then logo will appear and become initial stage.



Press the power button during “1 second” in active state, power turns off.

### 8.2 X-ray generating time control

▲ : Increase time set-up

▼ : Decrease time set-up

### 8.3 Relation between X-ray generating time and part of teeth (Table)

The X-ray dose required for image acquisition can vary depending on the X-ray source and environmental circumstances. Dosage is directly related to tube voltage(kV), tube current (mA), distance from the tube to the teeth and receptor, and exposure time. Voltage and current are fixed on our device, and the minimum distance is determined by cone length, so you can only adjust x-ray dose through exposure time.

Correct exposure time varies depending on the age, gender and bone density of the patient. The recommended exposure dose is from 300  $\mu$  Gy to 600  $\mu$  Gy when measuring without an object.

For general issues pertaining to all radiographic imaging systems, you should refer to two sources for further information: first, the Image Gently Back to Basics campaign materials at <http://pedrad.org/associations/5364/ig/Procedures/DigitalRadiography/EducationalMaterials.aspx>; and second, the FDA Pediatric X-ray Imaging webpage <http://www.fda.gov/radiation-emittingproducts/radiationemittingproductsandprocedures/medicalimaging/ucm298899.htm>).

Additional guidelines for correct exposure times is found in the dosage table below. This table especially helps ensure that pediatric patients receive the minimum necessary amount of radiation while still producing diagnostic quality images.

Classification		Radiography area and expose time							
Classification by age	Adult	-	-						
	Children							-	-
Distance between product and skin: 0cm	Sensor	0.10 ~ 0.15	0.15 ~ 0.20	0.20 ~ 0.25	0.25 ~ 0.30	0.30 ~ 0.35	0.35 ~ 0.40	0.40 ~ 0.50	0.50 ~
	FILM	0.20 ~ 0.30	0.35 ~ 0.45	0.50 ~ 0.60	0.65 ~ 0.75	0.80 ~ 0.90	0.95 ~ 1.05	1.10 ~ 1.20	1.25 ~ 1.35
Distance between product and skin: 5cm	Sensor	0.15 ~ 0.20	0.25 ~ 0.30	0.30 ~ 0.35	0.40 ~ 0.45	0.45 ~ 0.50	0.55 ~ 0.60	0.75 ~ 0.80	0.90 ~
	FILM	0.25 ~ 0.30	0.30 ~ 0.35	0.40 ~ 0.45	0.45 ~ 0.50	0.55 ~ 0.60	0.60 ~ 0.65	0.85 ~ 0.90	1.0 ~

## 8.4 X-ray EXPOSURE

Using Hand-Held

 button : Exposing of X-ray with buzzer sound only while the button is being pressed.



X-ray is generated only while  button is pressed. So even though the buzzer sound is being made, the generation of X-Ray stops when taking the hand off the button.





Setting time is stored to product that do exposure on last. Time is not stored that do not exposure.

The status indication changes from READY to EXPOSURE while the X-Ray is being generated.

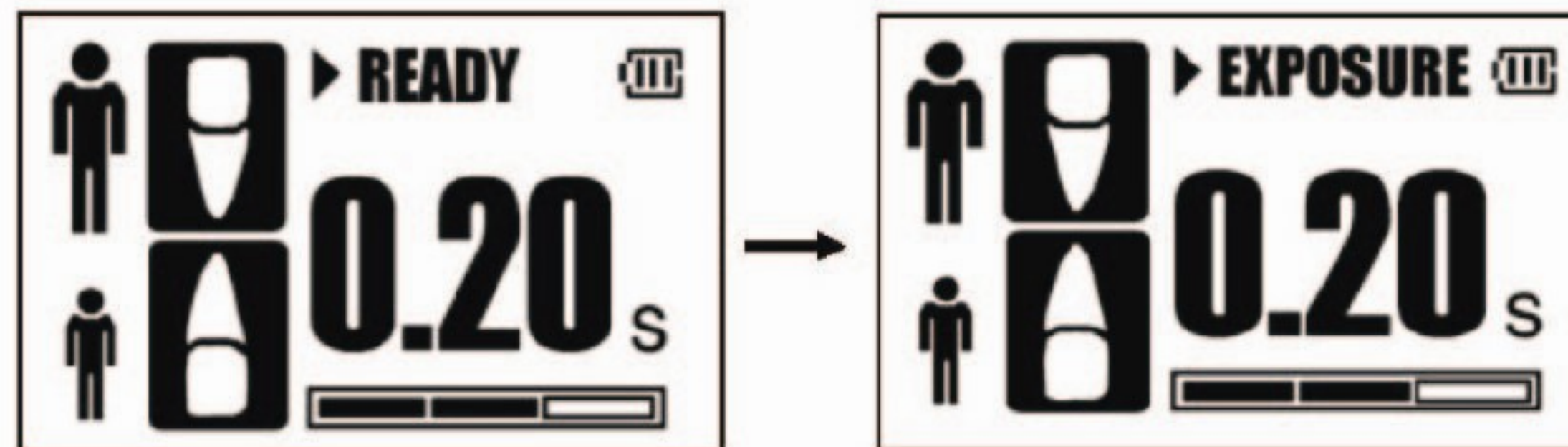

READY → EXPOSURE State Change

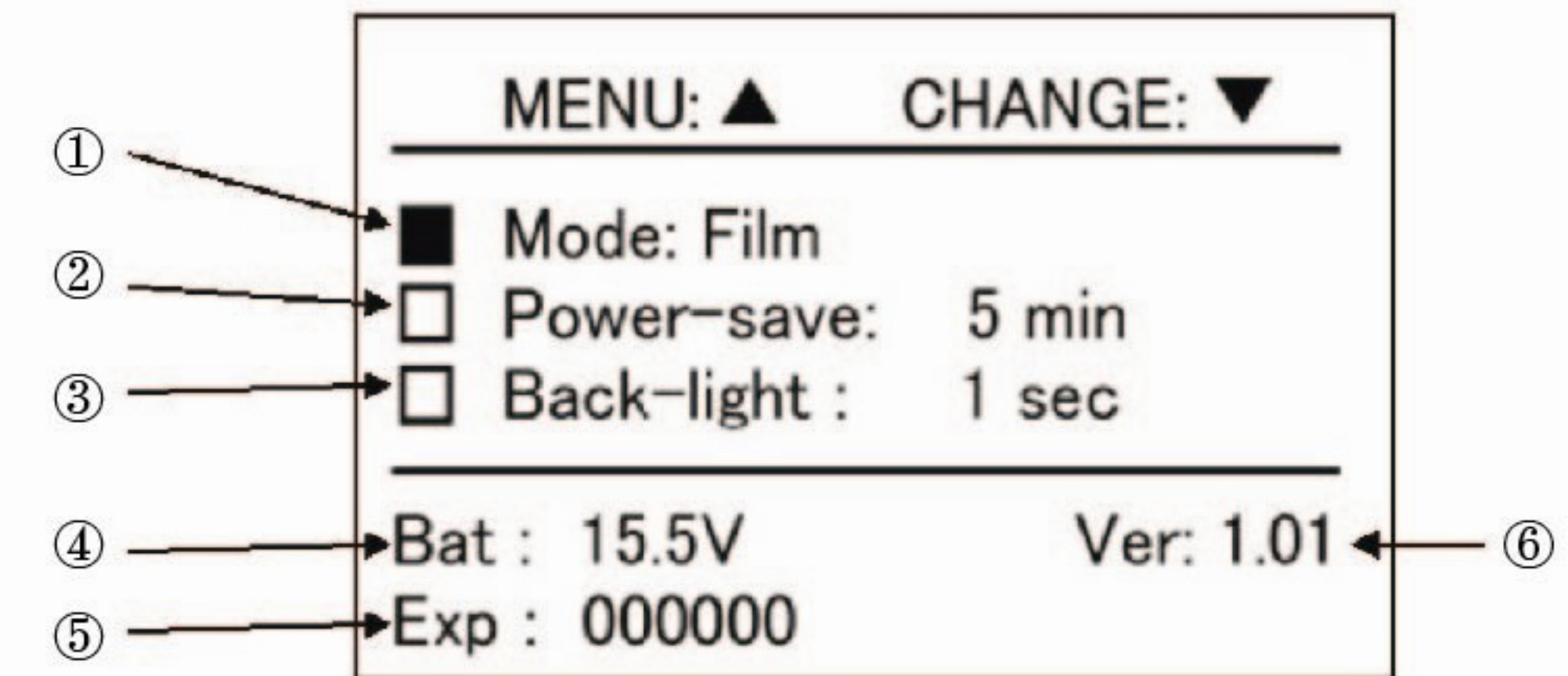

## 8.5 User Set Up Mode

At the status of power on, pressing the  and  together and then releasing, you will enter into User Set-up Mode





- Move between menu :  button
- Change the set up value :  button

- Exit the user set up mode : After turning off the unit by pressing , turn on the unit again, then unit starts with changed mode and set up value.

Menu explanation :

- ① Mode : Film ; film/digital mode indicates
- ② Power-save ; automatic power disconnection time (default : 5 min)
- ③ Back-light ; activating of back-light (default :1sec)
- ④ Bat ; remaining voltage of battery
- ⑤ Exp ; the number of time of EXPOSURE of the unit
- ⑥ Ver. 1.01 ; version of the unit

### ① Film/Digital mode

Using  button, locate the menu in "Set up Mode" position, and by pressing the  button, film mode or digital mode can be selected.

When digital mode is selected, the digital mode icon is displayed as followings ;

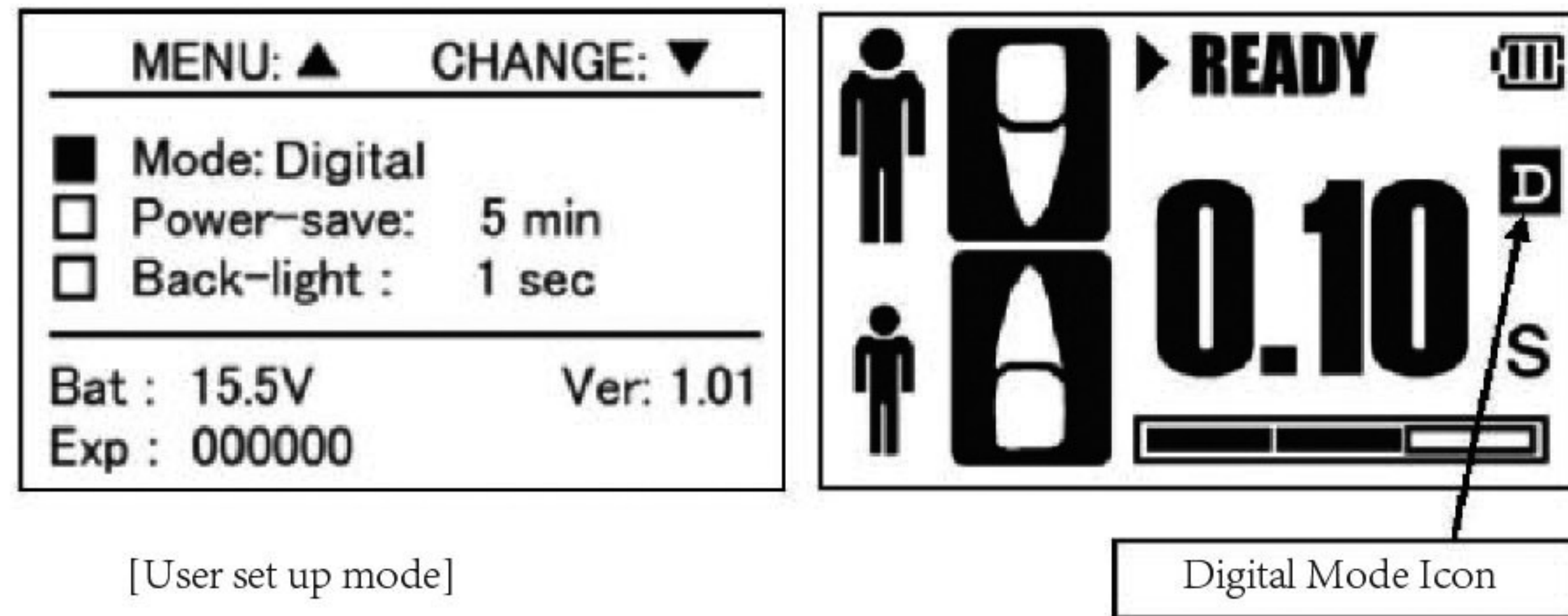

[User set up mode]

Digital Mode Icon



For film mode, exposure time is from 0.2s up to 1.35s, for digital mode, exposure time is from 0.05s up to 1.20s, each mode has 24 steps of ranges.

### ② Automatic power disconnection time

While the unit is not in use, the power is automatically disconnected following by the set-up time in order to save unnecessary power consumption.

Default is set-up as 5 minute and it could be adjusted by 1 minute. According to the convenience of the user interval from 1 minute up to 10 minutes.

### ③ Back-light activating time



- The light illuminating time can be set for LCD window.
- Basically, setting value of 1 second is given and can be adjusted by 1 second up to 10 second for user convenience.

### ④ Remaining voltage of battery

- Display value of voltage that is remained in battery-pack

### ⑤ Numbers of times of exposure of the unit

- Display the number of exposure times of the unit up to now

### ⑥ Version of the unit

- Displays the version of the present unit

## 8.6 Replacing and charging of battery-pack



Change with the extra battery pack when the LOW battery direction lamp starts flicking.



[Low battery screen]

- Turn off, if LOW battery sign appears. Please open battery pack cover (side of product) and change with extra battery pack.
- Battery pack cover opens by pulling forward after press fixing lever down.
- Put homologizing correctly battery pack insertion slot and guide line.
- Please close cover after making sure battery pack came to end certainly.

[Auto power off]

- Power lamp flicking or LOW battery indication appears on LCD screen, stop using and replace with the charged battery-pack.

- If use continuously without replace of battery after LOW battery patent appears, the power will be shut off automatically.

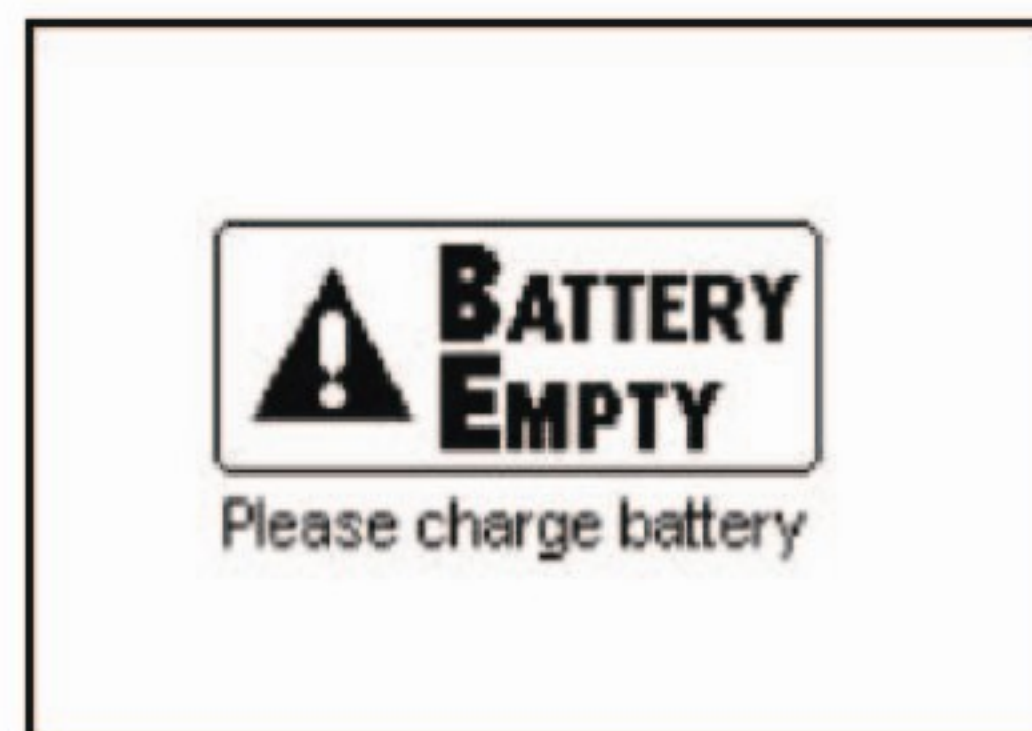

[Auto power off screen]



## 9. Maintenance and Keeping

Keep the unit and the battery-pack in the place where only authorized personnel can reach.

Please clean often the product by using piece of cloth and to keep radiation aperture's clean because patients are contacted directly.

Do not put the unit close to the heat such as stove and heating device during using.

Please do not remodel device arbitrary.

For safe use, it is recommended to have the unit checked regularly at the designated A/S Center.

For using and keeping, avoid as following places ;

- Damp places
- Places in the direct ray of light
- Dusty places
- Moist places
- Places in poor ventilation
- Salty places
- Where there is explosive gas or with chemicals.

Product transportation, storage conditions and conditions of use ;

1. Transportation and storage conditions

- Temperature: 0 ~ 40 °C

- Humidity: 30 ~ 75 %

- Atmosphere pressure: 700 ~ 1060Hpa

2. Optimal conditions of use

- Temperature condition of use: 10 ~ 30 °C

- Humidity condition of use: 30 ~ 60 %

- Atmosphere pressure condition of use: 900 ~ 1060Hpa





## Maintenance and Keeping

### Safe-keeping (MX-Plus)

- Keep the unit avoiding the place where it is damp and in the direct ray of light.
- Do not keep the unit where it is dusty, dirty, and sloping.
- Do not keep the unit where it is so high temperature, or so low temperature.
- When the unit is not in use for long, remove the battery-pack and keep it separately.

### Safe-keeping of the charger and the table-top device for charging;

- Care has to be taken not to let the foreign material be stick at the terminal of the charging device. It has to be kept after lightly cleaning with cotton bud or soft cloth
- When not in use, take the plug off the outlet, and when it will not be used for long, keep it in the case.
- Be careful of metal material such as coins, key, and clip, etc.) not to be contacted with terminal plate of battery-pack or charger.
- Do not attempt to use charger with other makers' battery



## Maintenance and Keeping

### Daily / Monthly tests and Annual maintenance

#### 1) Daily tests

- When turned on power of product, please confirm whether on sound is heard and normal early screen appears.
- Change establishment investigation time using manufacturing button and time confirms whether is changed normally in display.
- Please confirm whether buzzer sound is heard and "EXPOSURE" phrase and investigation lamp of LCD screen are seen normally at X-ray exposure.
- Please confirm charging of battery pack and normal operation existence and nonexistence of charger.

#### 2) Monthly tests

- Please confirm whether duration of use of used battery pack is suitable. Buy new battery pack if duration of use decreases comparing with first purchase by half.



Battery pack is consumer goods, duration of use is shorted slowly than bought.

#### 3) Annual maintenance

- Every year for safe use of product, safety check-up is necessary.

## 10. Instruction & Troubleshooting guidelines

User should check below symptoms list before asking repair.

Symptoms	Management
Battery indication lamp is flicking	<ul style="list-style-type: none"> <li>- Check the remaining battery, and replace with charged battery</li> <li>- Ensure if the battery - pack cover is properly closed, and if the cover open, close the cover completely to the end.</li> </ul>
The sound of Power On or LCD window does not work when the unit is turned on	<ul style="list-style-type: none"> <li>- Check if the battery - pack is loaded or replace the battery- pack.</li> <li>- If the battery will not be used for long time, separate the battery from the unit for prevention discharge.</li> </ul>
LCD window is not lit after the sound of Power On is heard.	<ul style="list-style-type: none"> <li>- Replace the battery - pack. ( If the status remain same even after having replaced the battery, contact with the designated A/S Center for repair)</li> </ul>
The power turns off itself while in use	<ul style="list-style-type: none"> <li>- Check the remaining battery</li> <li>- This unit features automatic power disconnection to save the unnecessary consumption of the battery- pack. Check the set - up of the automatic power disconnection</li> </ul>

## 11. Quality Guaranteed

This product is warranted its quality from the date of purchase to one-year.

It is hard to recognize the warranty period, the warranty is applicable three months after it was manufactured.

Products defects by itself or improper workmanship, the product will be either repaired free of charge or exchanged according to the status of the product.

Even within the warranty period, if the damage is caused by failure of the user, free of charge is not applied.

The attached level for sealing is broken, free of charge and warranty are not applied.

The repair at the place any other than designated A/S Center is excluded from warranty

The service period will not be extended for the product which was repaired with charge or free of charge.











## 12. Warranty

Name of Product		Portable X-ray System	Name of model	MX-Plus
Date of Purchase		20	Place of Purchase	
INFO	Name		Phone	
	Address			
<p>The product of Resun Co., Ltd. observes regulation for protection of consumers notified by The Ministry of Economy.</p> <p style="text-align: center;"><b>SUNUP</b></p> <p>Taizhou Zhonglian medical technology Co.,Ltd          Adress: #168 west Phoenix road Taizhou China          Sales call: 0086-523-89993222      Service: 008613357797788          E-mail:sunup@cn-sunup.cn      Http://www.cn-sunup.cn</p>				

## 13. Instruction for Quick Start

Quick Start summarized tables which are explained in the user manual. This explanation can not take whole explanation of product use method. This is just for user convenience to help understand the unit prior to actual use. Based on this summarized Quick Start, use the unit after having read the manual completely without fail. If you use this unit after familiarized with it, you can easily use with Quick Start.

## Instruction for Quick Start

Ready	Insert the battery-pack into the unit
Power ON	Using  Button, turn the unit on and LCD window is lit with sound
Check	Check the balance of battery-pack and make sure the conditions of the product
Mode selection	Select the method of radiography such as film or digital sensor
Exposure time	Select the exposure time by location of teeth for radiography
Radiography	Radiography the area of patient's teeth using film (Digital sensor)
Power Off	After press  button, LCD screen turns off with OFF sound
Operating Method	<ul style="list-style-type: none"> <li>- Power On / Off :  button</li> <li>- How to set up the mode of radiography               <ul style="list-style-type: none"> <li>① User set-up mode  + </li> <li>② Move the menu </li> <li>Change the mode </li> </ul> </li> <li>- Select the time               <ul style="list-style-type: none"> <li>① Increase set-up time </li> <li>② Decrease set-up time </li> </ul> </li> <li>- EXPOSURE of X-Ray :  Button</li> </ul>

## Service Manual

## Specification

Manufacturer : Resun Co. Ltd..

Name of Medical equipment : Portable X-ray System

Model : MX-Plus

Device Classification : Class II b (MDD 93/42/EEC as amended by 2007/47/EC)

Classification

Type of protection against electric shock

: Internal powered equipment

Degree of protection against electric shock

: TYPE B Applied part

Voltage range: 12V ~ 16.8V DC

Power consumption:240W Max.

Applications

This product has to be used only for dental diagnostic X-ray system for dental or extra-oral X-ray radiograph.

Battery-pack

- Material : Lithium-Polymer

- Charge Condition

Current : 1.0 A

Voltage : 16.8 VDC

Temperature : 0 ° C ~ 40 ° C

-

Use condition

Max. current : 20A

Voltage range : 12(min) ~ 16.8(MAX) V

Temperature : -20 ° C ~ 60 ° C

Charger

- Input Voltage : 100 ~ 240 VAC

- Output Voltage : 16.8 VDC

- Current : 1.0A



## High Voltage Tank

X-ray tube : D-0712

I.Model : D-0712

II.Manufacture : TOSHIBA

III.Electrical Data

- Circuit : Self-rectified (Center-grounded)
- Operating Tube Voltage : 50kV ~ 65kV Max
- Focal Spot : 0.7 [mm]
- Max. Input Energy (at 1.0s) : 600W(refer to rating charts)

IV.Mechanical Data

- Dimensions

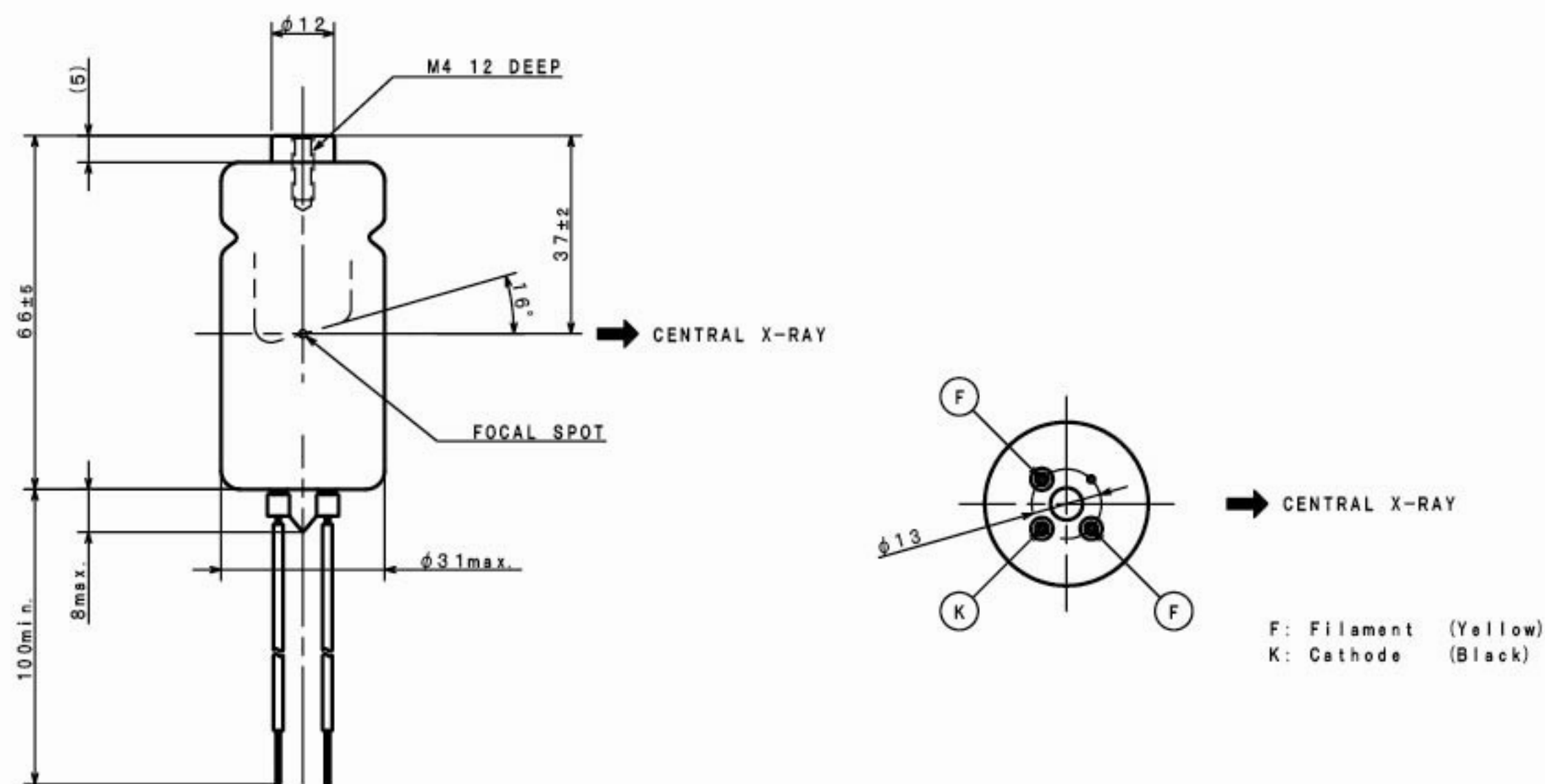

- Overall length : 66 mm
- Max. Diameter : 31 mm
- Target Angle : 16 degrees
- Inherent Filtration : 0.7 mm Al
- Weight (Approx.) : 96g
- Cooling Method : Oil cooling

## High Voltage Tank

V.Maximum and Minimum Ratings

- Maximum Tube Voltage : 70kV
- Maximum Inverse Tube Voltage: 80kV
- Maximum Tube Current :19mA (see rating charts)
- Maximum Filament Current : 3.1A
- Filament Voltage : 2.68~3.62V (At max. filament current)
- Temperature Characteristics
  - Anode Heat Storage Capacity : 4.3 kJ(8.5KHU)
  - Max. Anode Heat Dissipation Rate : 100 W(180HU/s)

Maximum Rating Charts (Absolute Maximum Rating Charts)

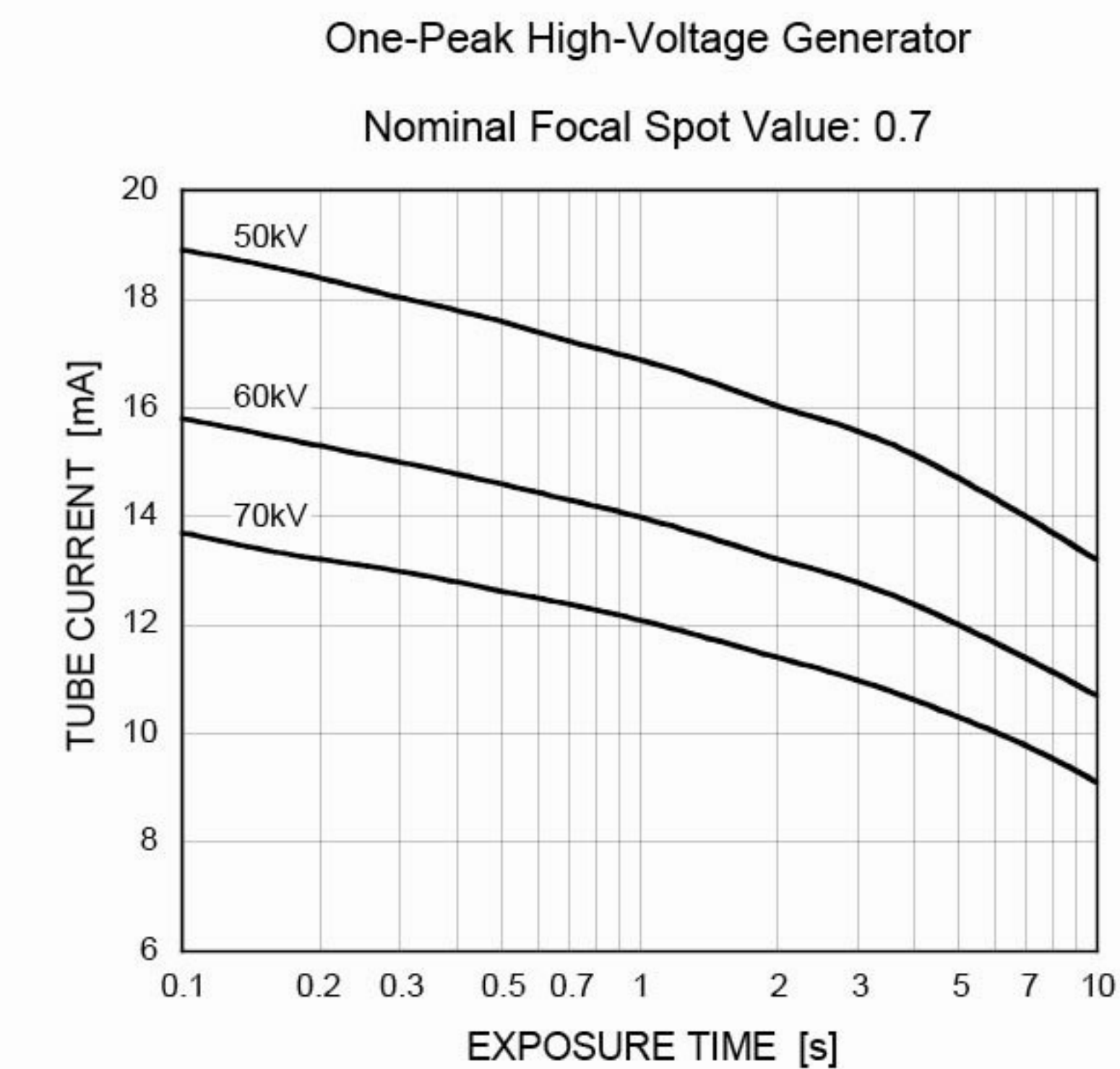

# High Voltage Tank

Emission & Filament Characteristics

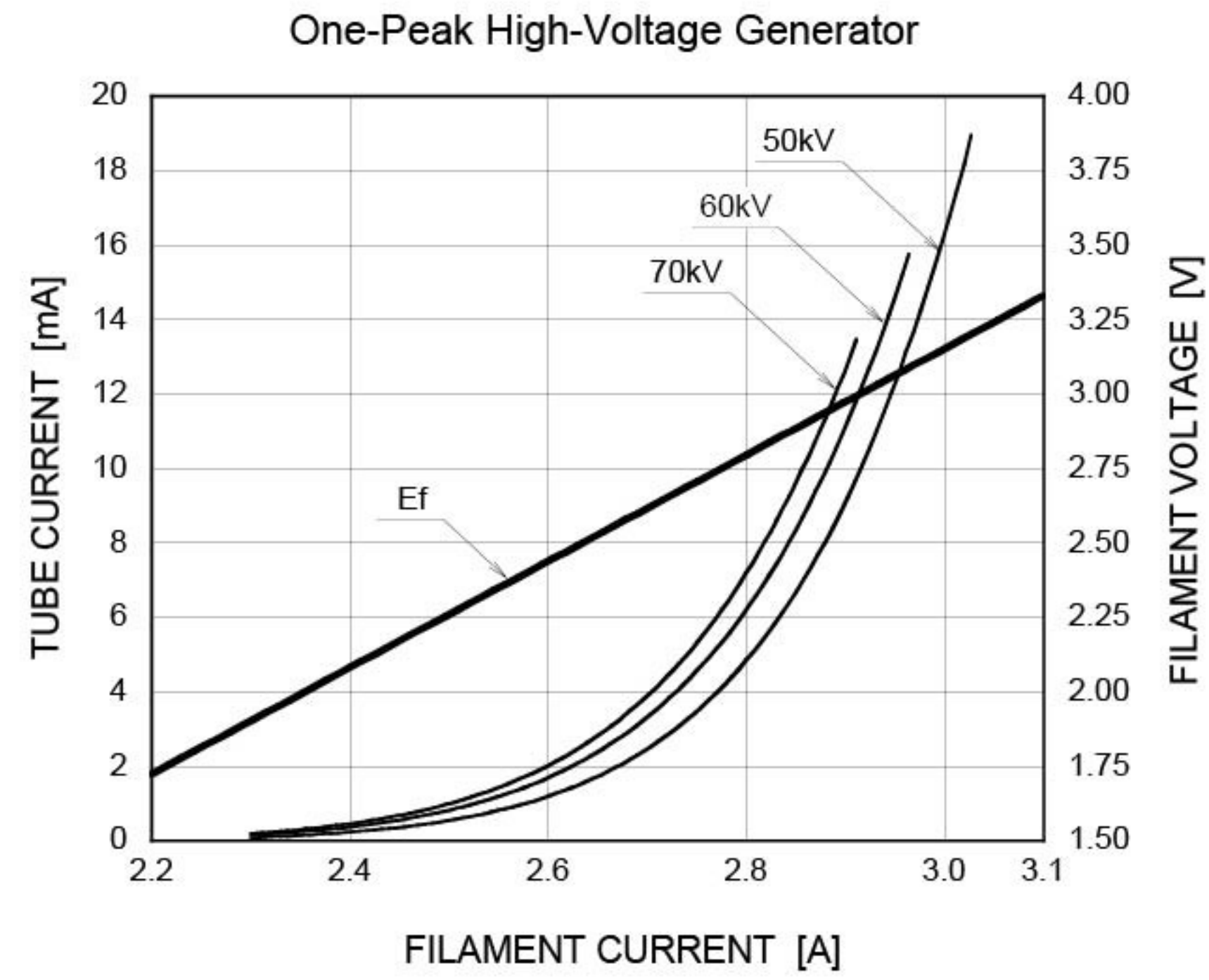

Anode Thermal Characteristics

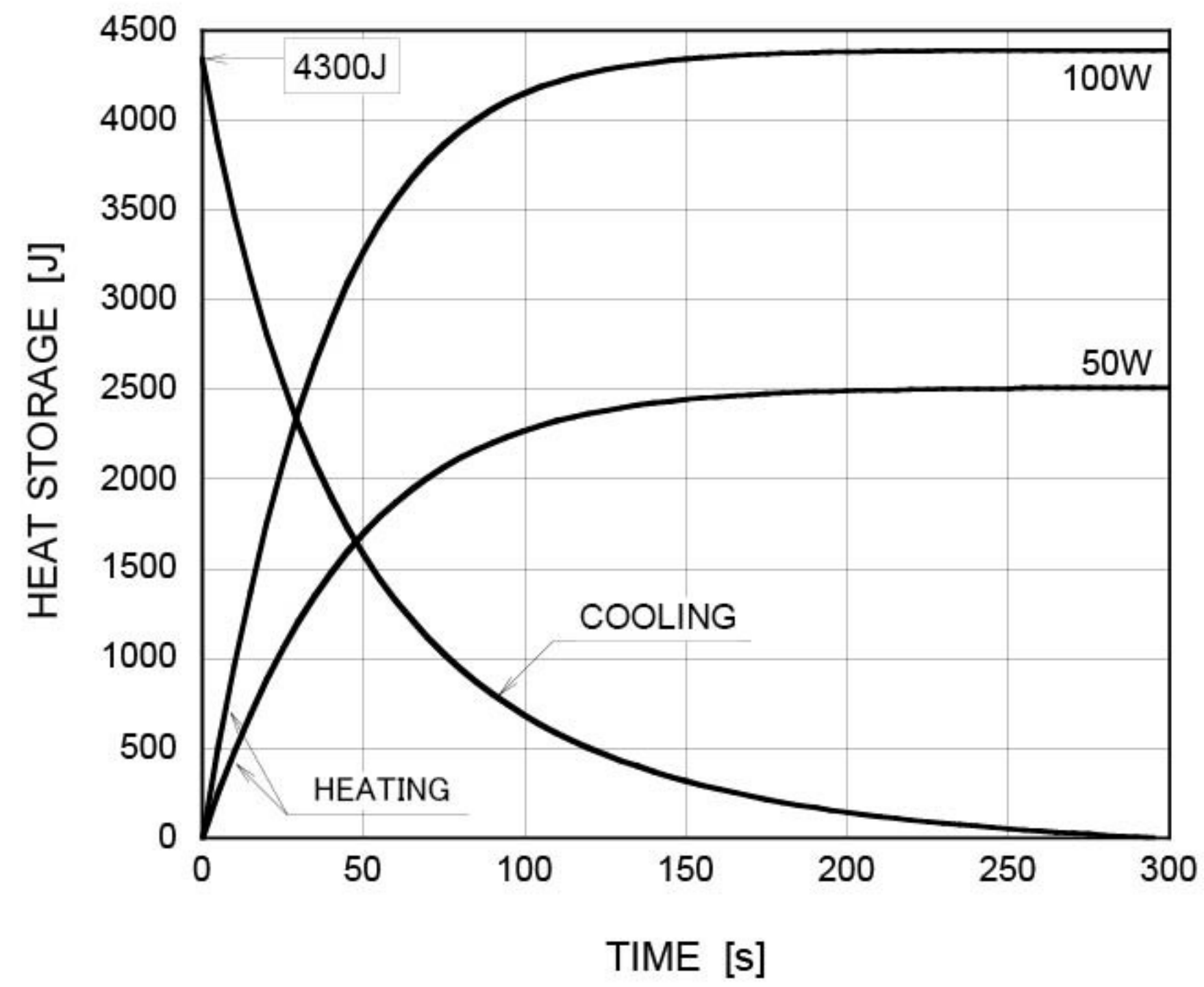

# High Voltage Tank

Distance from focal spot to radiation aperture and the diameter of X-ray field [mm]

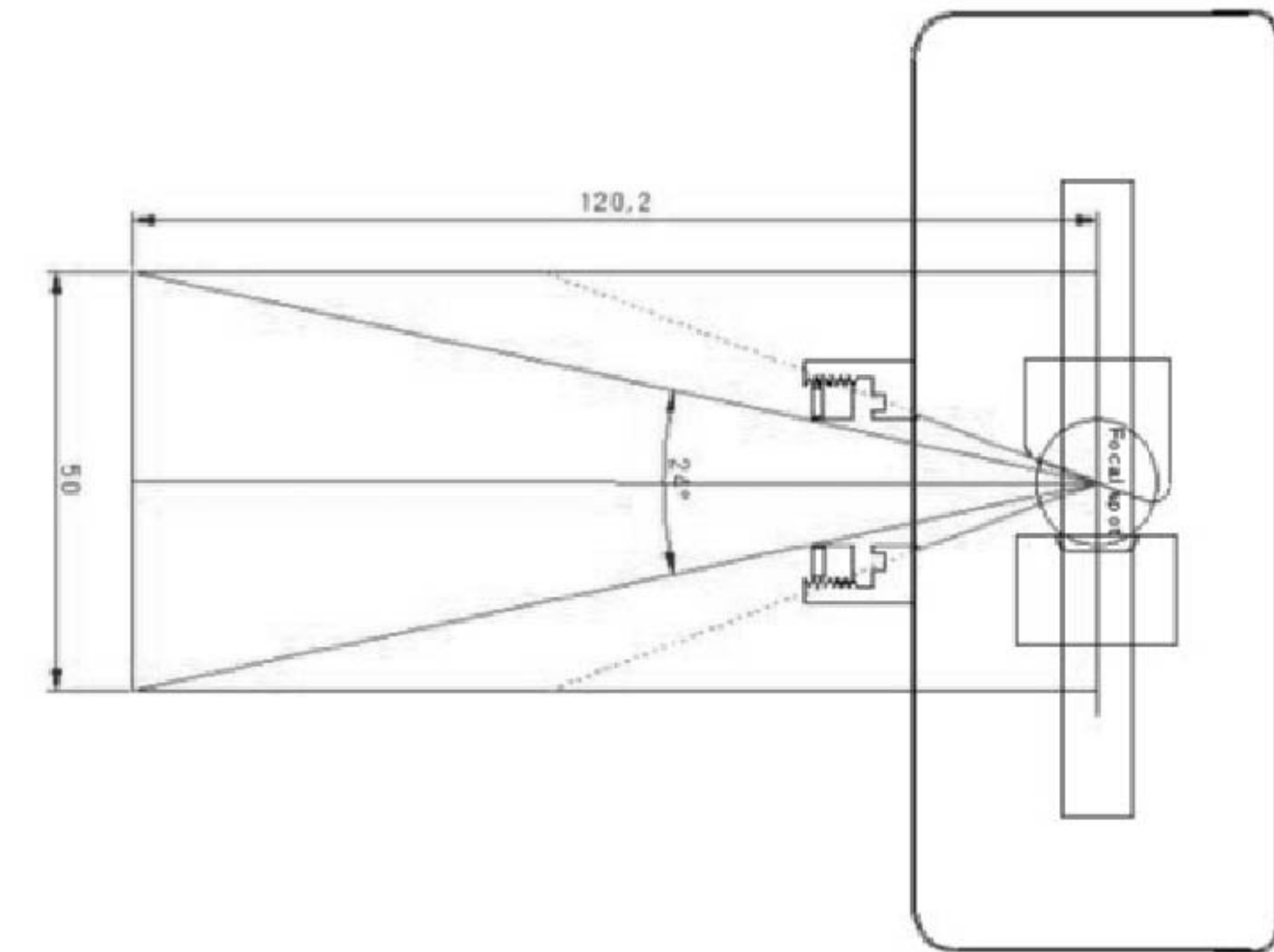

## Electro-Magnetic Compatibility (EMC)

As this product is used without connection of a cable, there is no EMC risk.

This product has EMI characteristics, less than 4.9dB at 1000MHz, which may make an interference with another device having similar characteristics. Avoid to use together with these devices (Refer to table 1).

Keep away from devices which make a serious radiation noise or a strong electromagnetic field (Refer to table 2).

As this product is not used with cable, there is no risk of EMC interference with another device through the cable. If this product is remade for connection with another device or part intentionally, it will make an interference with another device, the manufacture don't take responsibility for risk of EMC (Refer to EMC part of Service manual).

## Electro-Magnetic Compatibility (EMC)

### Electro-Magnetic Interference

Radiated emission (electric field) : 30Mhz ~ 1000MHz

Min. limit margin : 4.9 dB at 1000 MHz

Radiated emission data

Table 1

Freq. MHz	Antenna Pol. H/V	Reading Level dBuV	Correction (AF+CL)	Emission Level	Limit (10m) dBuV/m	Margin dBuV
1000	H/V-	<2.0	dB/m 30.1	<32.1	37	>4.9

### Electro-Magnetic Susceptibility

Table 2

Radiated Field	Frequency range	Field strength	Modulation	Frequency step
	80-2500 MHz	3 V/m 10 V/m	AM 80% 1KHz sine wave	1% / 3s
Magnetic Field	Test frequency	Field level (EMF)	Duration	Axis of orientation
	50 Hz	3 A/m	60 seconds each axis	X, Y, Z axis



## Radiation safety

### 1. Leakage radiation

The following is leakage radiation at 1m from focal spot.

Unit: [mR/h, (mGy/h)]

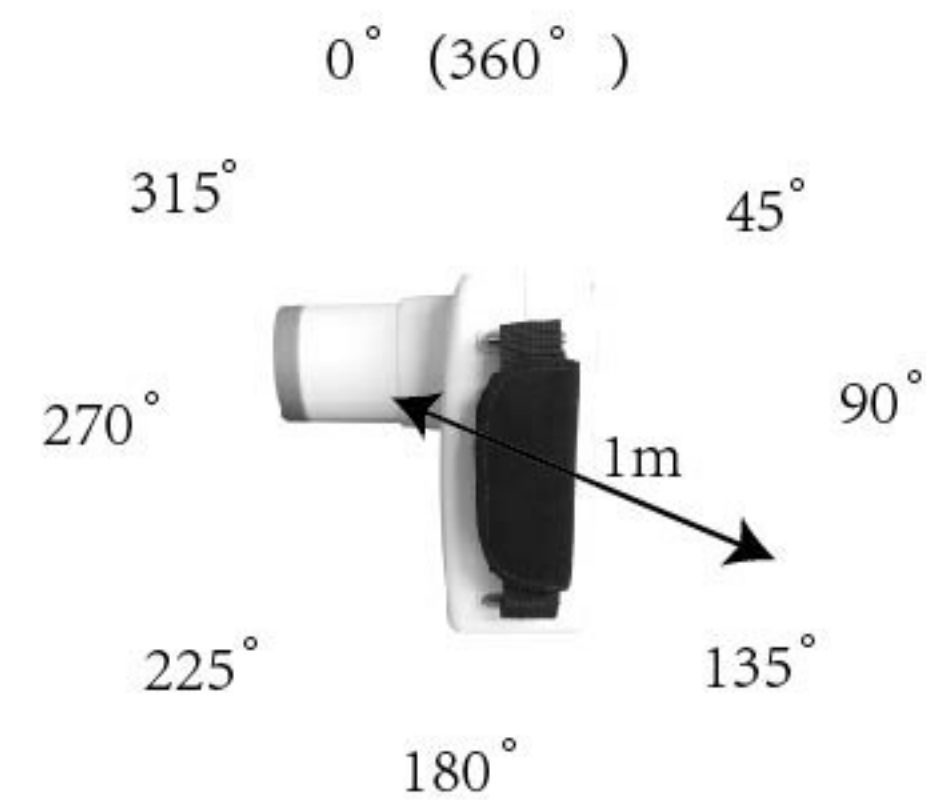

	Test 1	Test 2	Test 3
0° (360°)	ND	ND	ND
45°	ND	ND	ND
90°	ND	ND	ND
135°	ND	ND	ND
180°	ND	ND	ND
225°	ND	ND	ND
270°	ND	ND	ND
315°	ND	ND	ND

ND : Not Detected

The following is leakage radiation at 1cm from case surface.

Unit: [mR/h, (mGy/h)]

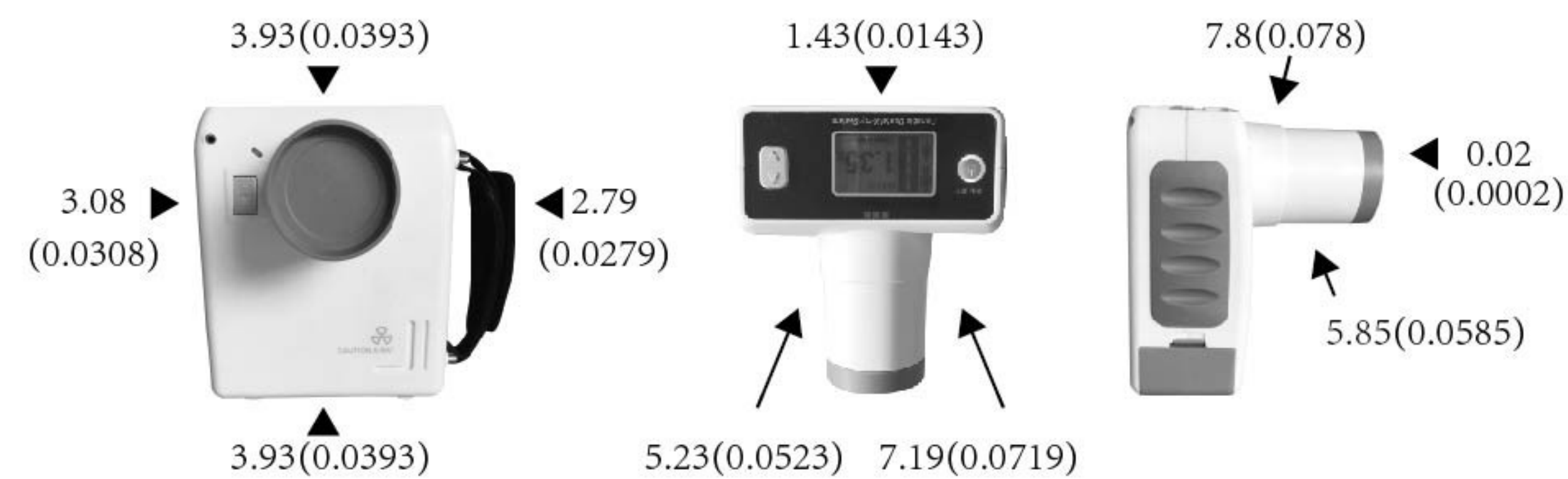

Leakage radiation at 1cm from case surface is less than 8mR/h(0.08mGy/h).

## Radiation Safety

### 2. Strayed Radiation

The following designate significant zone of occupancy.

Please put private protection devices within this area.

#### 2-1. Set the significant zone of occupancy

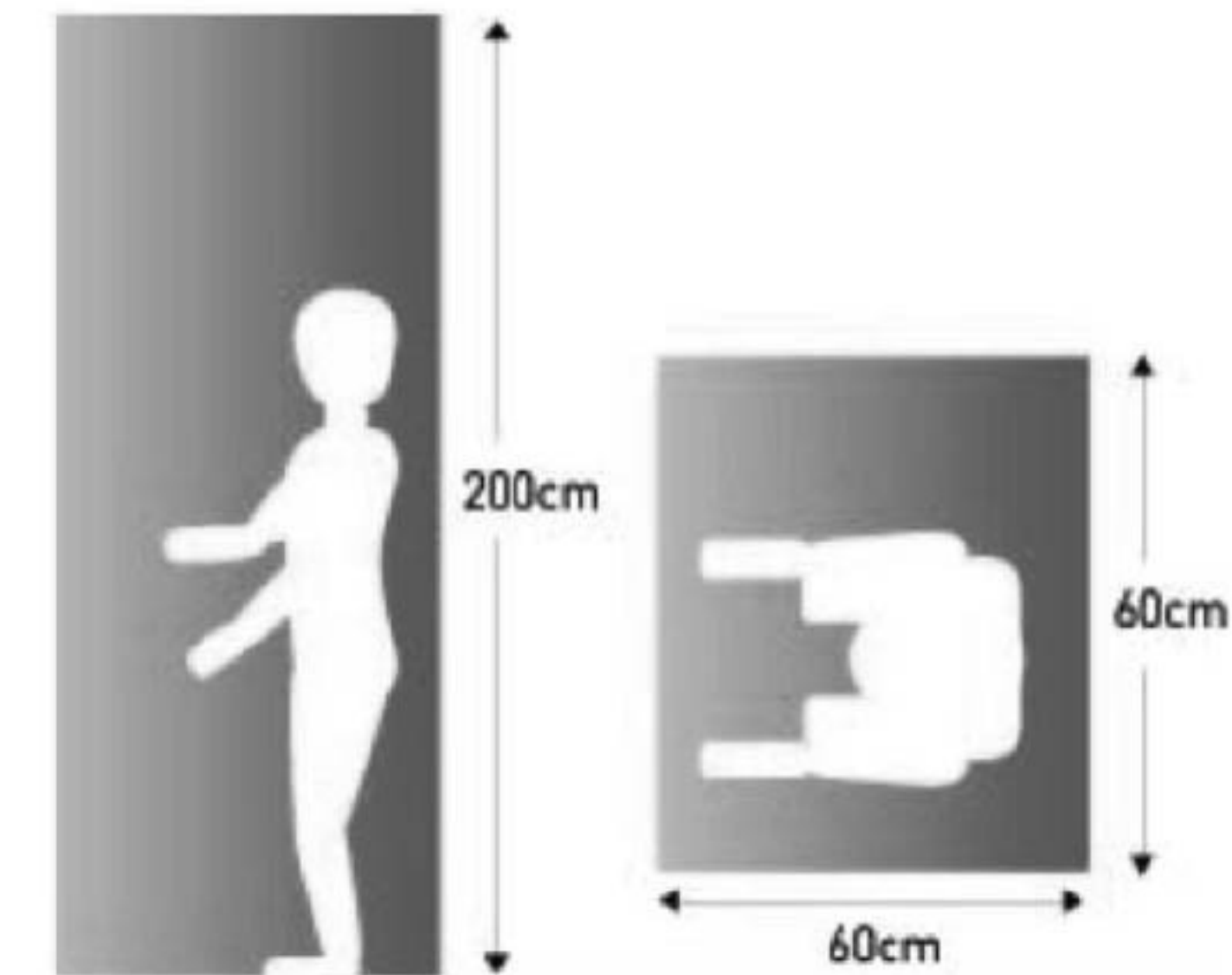

significant zone of occupancy

# Radiation Safety

## 2-2. Test method and result of stray radiation

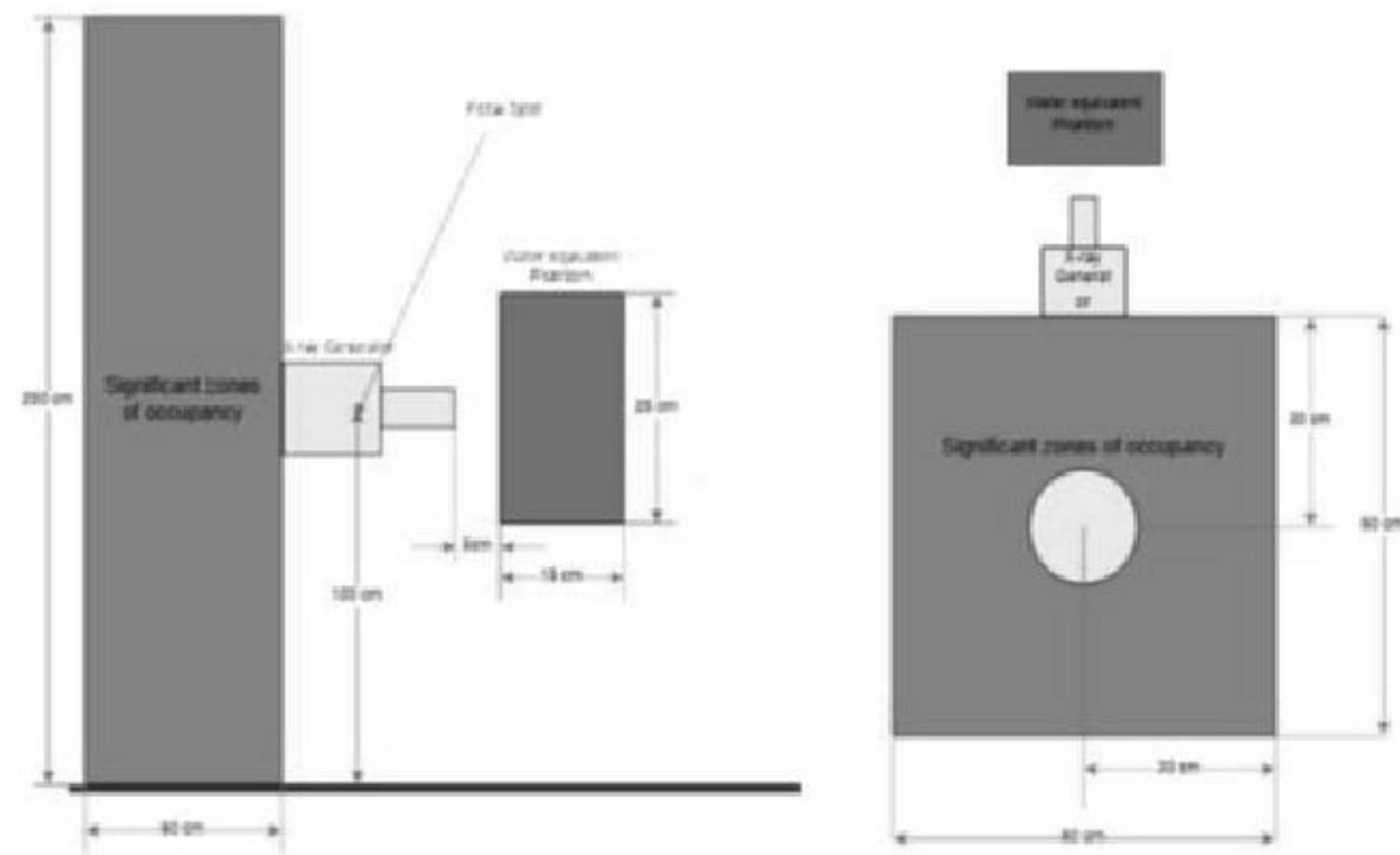

Test Method of stray radiation

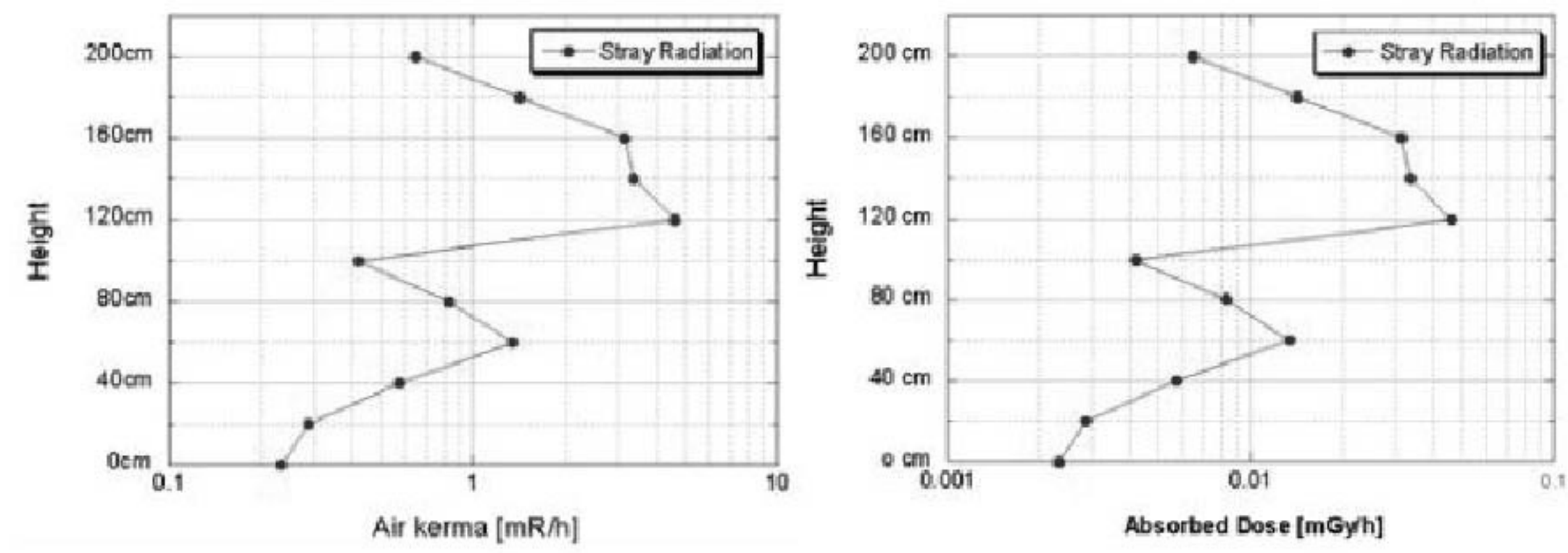

Test result of stray radiation